



**finder**<sup>®</sup>  
SWITCH TO THE FUTURE

**48**  
SERIES

# Relay Interface Modules 8 - 10 - 16 A



Control panels



Carousel  
warehouses



Medical and  
dentistry



Shipyards



Elevators and  
lifts



Panels for electrical  
distribution



Building  
automation



Hoists and cranes

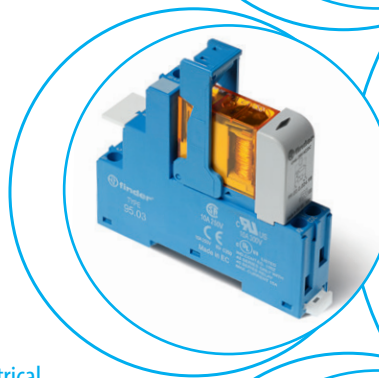



FINDER reserves the right to alter characteristics at any time without notice. FINDER assumes no liability for damage to persons or property, caused as a result of the incorrect use or application of its products.

**2 CO relay interface modules,  
15.8 mm wide**

**Type 48.12**

**Ideal for safety applications**

- 2 CO 8 A
- Screw terminals
- Relay with forcibly guided contacts according to EN 61810-3 Type B (previously EN 50205)

**Type 48.32**

**Ideal for energy applications**

- 2 CO 8 A
- Breaking capacity DC inductive (L/R=40 ms)
  - 110 V = 0.5 A
  - 220 V = 0.2 A
- Screw terminals

- DC coils
- Identification label
- UL Listing (certain relay / socket combinations)
- 35 mm rail (EN 60715) mounting
- Cadmium-free contact material

48.12/32  
Screw terminal



According to EN 61810-3 only 1 NO and 1 NC (11-14 and 21-22 or 11-12 and 21-24) shall be used as forcibly guided contacts (Type 48.12).

For outline drawing see page 11

**Contact specification**

Contact configuration		2 CO (DPDT)	2 CO (DPDT)
Rated current/Maximum peak current	A	8/15	8/15
Rated voltage/ Maximum switching voltage	V AC	250/400	250/400
Rated load AC1	VA	2000	2000
Rated load AC15 (230 V AC)	VA	500	500
Single phase motor rating (230 V AC)	kW	0.37	0.37
Breaking capacity DC1: 30/110/220 V	A	8/0.65/0.4	8/0.65/0.4
Minimum switching load	mW (V/mA)	50 (5/5)	50 (5/5)
Standard contact material		AgNi+Au	AgNi+Au

**Coil specification**

Nominal voltage (U <sub>N</sub> )	V DC	12 - 24	24
Rated power DC	W	0.7	0.7
Operating range	DC	(0.75...1.2)U <sub>N</sub>	(0.75...1.2)U <sub>N</sub>
Holding voltage	DC	0.4 U <sub>N</sub>	0.4 U <sub>N</sub>
Must drop-out voltage	DC	0.1 U <sub>N</sub>	0.1 U <sub>N</sub>

**Technical data**

Mechanical life DC	cycles	10 · 10 <sup>6</sup>	10 · 10 <sup>6</sup>
Electrical life at rated load AC1	cycles	100 · 10 <sup>3</sup>	100 · 10 <sup>3</sup>
Operate/release time	ms	10/4	10/4
Insulation between coil and contacts (1.2/50 μs)	kV	6 (8 mm)	6 (8 mm)
Dielectric strength between open contacts	V AC	1500	1500
Ambient temperature range	°C	-40...+70	-40...+70
Protection category		IP 20	IP 20

**Approvals relay** (according to type)



**48.12**

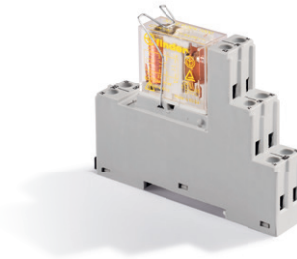

- 2 CO 8 A
- Screw terminals

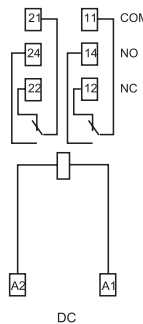

**NEW 48.32**

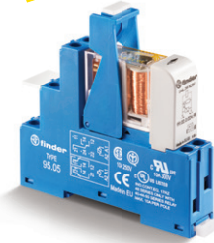

- 2 CO 8 A
- Screw terminals

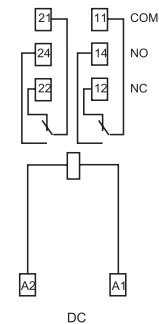

B

1 CO relay interface modules,  
15.8 mm wide  
Ideal interface for PLC and electronic systems

**Type 48.P3**

- 1 CO 10 A
- Push-in terminals

**Type 48.31**

- 1 CO 10 A
- Screw terminals

- AC coils or DC sensitive coils
- Supply status indication and EMC coil suppression module as standard
- Identification label
- UL Listing (certain relay/socket combinations)
- 35 mm rail (EN 60715) mounting
- Cadmium-free contact material

48.P3  
Push-in terminal

48.31  
Screw terminal



**48.P3**



- 1 CO 10 A
- Push-in terminals

**48.31**

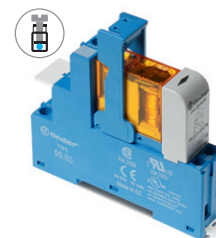

- 1 CO 10 A
- Screw terminals

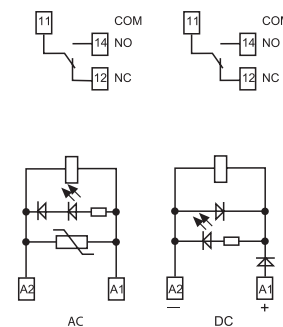
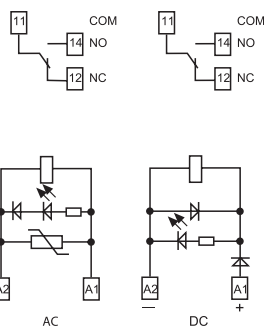

For outline drawing see page 11

**Contact specification**

Contact configuration		1 CO (SPDT)	1 CO (SPDT)
Rated current/Maximum peak current	A	10/20	10/20
Rated voltage/Maximum switching voltage	V AC	250/400	250/400
Rated load AC1	VA	2500	2500
Rated load AC15 (230 V AC)	VA	500	500
Single phase motor rating (230 V AC)	kW	0.37	0.37
Breaking capacity DC1: 30/110/220 V	A	10/0.3/0.12	10/0.3/0.12
Minimum switching load	mW (V/mA)	300 (5/5)	300 (5/5)
Standard contact material		AgNi	AgNi

**Coil specification**

Nominal voltage (U <sub>N</sub> )	V AC (50/60 Hz)	12 - 24 - 110 - 120 - 230	12 - 24 - 110 - 120 - 230
	V DC	12 - 24 - 125	12 - 24 - 125
Rated power AC/sens. DC	VA (50 Hz)/W	1.2/0.5	1.2/0.5
Operating range	AC	(0.8...1.1)U <sub>N</sub>	(0.8...1.1)U <sub>N</sub>
	sens. DC	(0.73...1.5)U <sub>N</sub>	(0.73...1.5)U <sub>N</sub>
Holding voltage	AC/DC	0.8 U <sub>N</sub> / 0.4 U <sub>N</sub>	0.8 U <sub>N</sub> / 0.4 U <sub>N</sub>
Must drop-out voltage	AC/DC	0.2 U <sub>N</sub> / 0.1 U <sub>N</sub>	0.2 U <sub>N</sub> / 0.1 U <sub>N</sub>

**Technical data**

Mechanical life	cycles	10 · 10 <sup>6</sup>	10 · 10 <sup>6</sup>
Electrical life at rated load AC1	cycles	200 · 10 <sup>3</sup>	200 · 10 <sup>3</sup>
Operate/release time	ms	7/4 (AC) - 12/12 (DC)	7/4 (AC) - 12/12 (DC)
Insulation between coil and contacts (1.2/50 μs)	kV	6 (8 mm)	6 (8 mm)
Dielectric strength between open contacts	V AC	1000	1000
Ambient temperature range	°C	-40...+70	-40...+70
Protection category		IP 20	IP 20

**Approvals relay** (according to type)



**2 CO relay interface modules,  
15.8 mm wide**  
**Ideal interface for PLC and electronic systems**

**Type 48.P5**

- 2 CO 8 A
- Push-in terminals

**Type 48.52**

- 2 CO 8 A
- Screw terminals

- AC coils or DC sensitive coils
- Supply status indication and EMC coil suppression module as standard
- Identification label
- UL Listing (certain relay/socket combinations)
- 35 mm rail (EN 60715) mounting
- Cadmium-free contact material

48.P5  
Push-in terminal



48.52  
Screw terminal



For outline drawing see page 11

**Contact specification**

Contact configuration		2 CO (DPDT)	2 CO (DPDT)
Rated current/Maximum peak current	A	8/15	8/15
Rated voltage/ Maximum switching voltage	V AC	250/400	250/400
Rated load AC1	VA	2000	2000
Rated load AC15 (230 V AC)	VA	400	400
Single phase motor rating (230 V AC)	kW	0.3	0.3
Breaking capacity DC1: 30/110/220 V	A	8/0.3/0.12	8/0.3/0.12
Minimum switching load	mW (V/mA)	300 (5/5)	300 (5/5)
Standard contact material		AgNi	AgNi

**Coil specification**

Nominal voltage (U <sub>N</sub> )	V AC (50/60 Hz)	12 - 24 - 110 - 120 - 230	12 - 24 - 110 - 120 - 230
	V DC	12 - 24 - 125	12 - 24 - 125
Rated power AC/sens. DC	VA (50 Hz)/W	1.2/0.5	1.2/0.5
Operating range	AC	(0.8...1.1)U <sub>N</sub>	(0.8...1.1)U <sub>N</sub>
	sens. DC	(0.73...1.5)U <sub>N</sub>	(0.73...1.5)U <sub>N</sub>
Holding voltage	AC/DC	0.8 U <sub>N</sub> / 0.4 U <sub>N</sub>	0.8 U <sub>N</sub> / 0.4 U <sub>N</sub>
Must drop-out voltage	AC/DC	0.2 U <sub>N</sub> / 0.1 U <sub>N</sub>	0.2 U <sub>N</sub> / 0.1 U <sub>N</sub>

**Technical data**

Mechanical life	cycles	10 · 10 <sup>6</sup>	10 · 10 <sup>6</sup>
Electrical life at rated load AC1	cycles	100 · 10 <sup>3</sup>	100 · 10 <sup>3</sup>
Operate/release time	ms	7/4 (AC) - 12/12 (DC)	7/4 (AC) - 12/12 (DC)
Insulation between coil and contacts (1.2/50 µs)	kV	6 (8 mm)	6 (8 mm)
Dielectric strength between open contacts	V AC	1000	1000
Ambient temperature range	°C	-40...+70	-40...+70
Protection category		IP 20	IP 20

**Approvals relay** (according to type)

**48.P5**

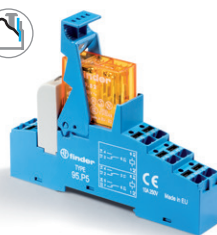

- 2 CO 8 A
- Push-in terminals

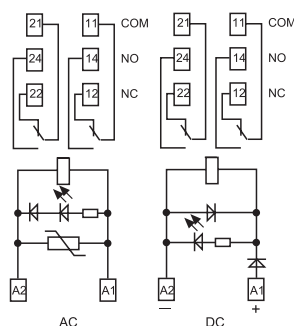

**48.52**

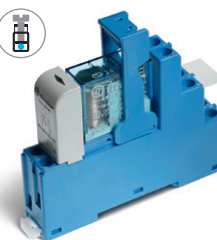

- 2 CO 8 A
- Screw terminals

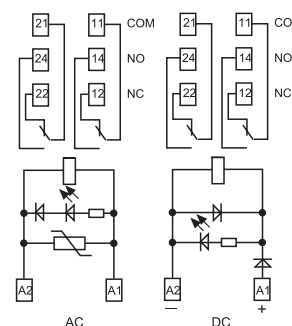

**1 CO relay interface modules,  
15.8 mm wide**  
**Ideal interface for PLC and electronic systems**

**Type 48.P6**

- 1 CO 16 A
- Push-in terminals

**Type 48.61**

- 1 CO 16 A
- Screw terminals

- AC coils or DC sensitive coils
- Supply status indication and EMC coil suppression module as standard
- Identification label
- UL Listing (certain relay/socket combinations)
- 35 mm rail (EN 60715) mounting
- Cadmium-free contact material available

48.P6  
Push-in terminal

48.61  
Screw terminal



For outline drawing see page 11

**Contact specification**

Contact configuration		1 CO (SPDT)	1 CO (SPDT)
Rated current/Maximum peak current	A	16*/30	16*/30
Rated voltage/ Maximum switching voltage	V AC	250/400	250/400
Rated load AC1	VA	4000	4000
Rated load AC15 (230 V AC)	VA	750	750
Single phase motor rating (230 V AC)	kW	0.55	0.55
Breaking capacity DC1: 30/110/220 V	A	16/0.3/0.12	16/0.3/0.12
Minimum switching load	mW (V/mA)	500 (10/5)	500 (10/5)
Standard contact material		AgCdO	AgCdO

**Coil specification**

Nominal voltage (U <sub>N</sub> )	V AC (50/60 Hz)	12 - 24 - 110 - 120 - 230	12 - 24 - 110 - 120 - 230
	V DC	12 - 24 - 125	12 - 24 - 125
Rated power AC/sens. DC	VA (50 Hz)/W	1.2/0.5	1.2/0.5
Operating range	AC	(0.8...1.1)U <sub>N</sub>	(0.8...1.1)U <sub>N</sub>
	sens. DC	(0.8...1.5)U <sub>N</sub>	(0.8...1.5)U <sub>N</sub>
Holding voltage	AC/DC	0.8 U <sub>N</sub> / 0.4 U <sub>N</sub>	0.8 U <sub>N</sub> / 0.4 U <sub>N</sub>
Must drop-out voltage	AC/DC	0.2 U <sub>N</sub> / 0.1 U <sub>N</sub>	0.2 U <sub>N</sub> / 0.1 U <sub>N</sub>

**Technical data**

Mechanical life	cycles	10 · 10 <sup>6</sup>	10 · 10 <sup>6</sup>
Electrical life at rated load AC1	cycles	100 · 10 <sup>3</sup>	100 · 10 <sup>3</sup>
Operate/release time	ms	7/4 (AC) - 12/12 (DC)	7/4 (AC) - 12/12 (DC)
Insulation between coil and contacts (1.2/50 μs)	kV	6 (8 mm)	6 (8 mm)
Dielectric strength between open contacts	V AC	1000	1000
Ambient temperature range	°C	-40...+70	-40...+70
Protection category		IP 20	IP 20

**Approvals relay** (according to type)

**48.P6**

- 1 CO 16 A
- Push-in terminals

**48.61**

- 1 CO 16 A
- Screw terminals

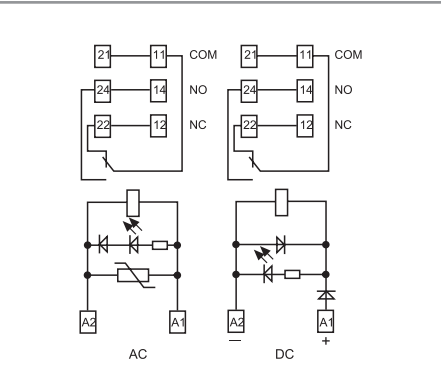

\* For currents > 10 A, contact terminals must be connected in parallel (21 with 11, 24 with 14, 22 with 12).

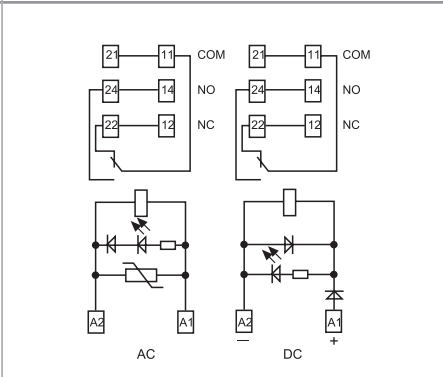

\* For currents > 10 A, contact terminals must be connected in parallel (21 with 11, 24 with 14, 22 with 12).



**2 CO relay interface modules,  
15.8 mm wide**  
**Ideal interface for PLC and electronic systems**

**Type 48.P8**

- 2 CO 10 A
- Push-in terminals

**Type 48.62**

- 2 CO 10 A
- Screw terminals

- DC sensitive coils
- Supply status indication and EMC coil suppression module as standard
- Identification label
- UL Listing (certain relay/socket combinations)
- 35 mm rail (EN 60715) mounting
- Cadmium-free contact material

48.P8  
Push-in terminal



48.62  
Screw terminal



**48.P8**

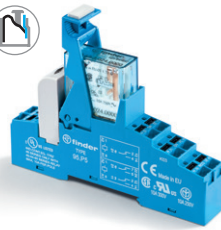

- 2 CO 10 A
- Push-in terminals

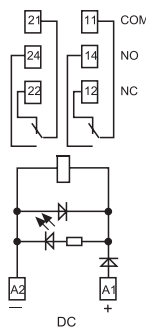

**48.62**

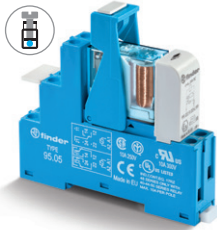

- 2 CO 10 A
- Screw terminals

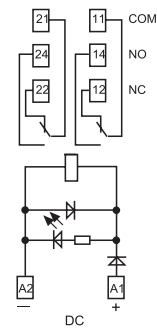

For outline drawing see page 11

**Contact specification**

Contact configuration		2 CO (DPDT)	2 CO (DPDT)
Rated current/Maximum peak current	A	10/20	10/20
Rated voltage/ Maximum switching voltage	V AC	250/400	250/400
Rated load AC1	VA	2500	2500
Rated load AC15 (230 V AC)	VA	750	750
Single phase motor rating (230 V AC)	kW	0.37	0.37
Breaking capacity DC1: 30/110/220 V	A	10/0.6/0.25	10/0.6/0.25
Minimum switching load	mW (V/mA)	300 (5/5)	300 (5/5)
Standard contact material		AgNi	AgNi

**Coil specification**

Nominal voltage (U <sub>N</sub> )	V AC (50/60 Hz)	—	—
	V DC	12 - 24 - 125	12 - 24 - 125
Rated power AC/sens. DC	VA (50 Hz)/W	—/0.5	—/0.5
Operating range	AC	—	—
	sens. DC	(0.8...1.5)U <sub>N</sub>	(0.8...1.5)U <sub>N</sub>
Holding voltage	AC/DC	—/0.4 U <sub>N</sub>	—/0.4 U <sub>N</sub>
Must drop-out voltage	AC/DC	—/0.1 U <sub>N</sub>	—/0.1 U <sub>N</sub>

**Technical data**

Mechanical life	cycles	10 · 10 <sup>6</sup>	10 · 10 <sup>6</sup>
Electrical life at rated load AC1	cycles	100 · 10 <sup>3</sup>	100 · 10 <sup>3</sup>
Operate/release time	ms	12/12 (DC)	12/12 (DC)
Insulation between coil and contacts (1.2/50 µs)	kV	6 (8 mm)	6 (8 mm)
Dielectric strength between open contacts	V AC	1000	1000
Ambient temperature range	°C	-40...+70	-40...+70
Protection category		IP 20	IP 20

**Approvals relay** (according to type)



## Ordering information

Example: 48 series, 35 mm rail (EN 60715) mount, Push-in terminal relay interface module, 2 CO 8 A contacts, 24 V sensitive DC coil, green LED + diode, 99.02 coil indication.

B

**4 8 . P 5 . 7 . 0 2 4 . 0 0 5 0**

### Series

### Type

Screw terminal

1 = 35 mm rail (EN 60715) mount,  
forcibly guided contacts relay

3 = 35 mm rail (EN 60715) mount

5 = 35 mm rail (EN 60715) mount

6 = 35 mm rail (EN 60715) mount

Push-in terminal

P = 35 mm rail (EN 60715) mount

### Type

Screw terminal

1 = for 48.31, 1 pole, 10 A

48.61, 1 pole, 16 A

2 = for 48.12/48.32 (DC only), 48.52, 2 poles, 8 A

48.62 (DC only), 2 poles, 10 A

Push-in terminal

3 = for 48.P3, 1 pole, 10 A

5 = for 48.P5, 2 pole, 8 A

6 = for 48.P6, 1 pole, 16 A

8 = for 48.P8 (DC only), 2 pole, 10 A

### Coil version

7 = Sensitive DC

8 = AC (50/60 Hz)

9 = DC (for 48.12 only)

### Coil voltage

See coil specifications

### A: Contact material

0 = Standard AgNi for

48.P3/P5/P8/31/52/62

AgCdO, Standard

for 48.P6/61

4 = AgSnO<sub>2</sub>, for 48.P6/P8/  
61/62 only

5 = AgNi + Au, for 48.12 and

48.P3/P5/31/52 only

Standard for 48.32

### B: Contact circuit

0 = CO (nPDT)

### D: Special versions

0 = Standard

7 = Standard (for 48.12 only)

### C: Options

0 = Standard (for 48.12 only)

5 = Standard for DC:

green LED + diode (polarity +A1)

6 = Standard for AC and 48.32:

green LED + Varistor

**Selecting features and options: only combinations in the same row are possible.**

Preferred selections for best availability are shown in **bold**.

Type	Coil version	A	B	C	D
48.12	DC	<b>5</b>	<b>0</b>	<b>0</b>	<b>7</b>
48.32	DC	<b>5</b>	<b>0</b>	<b>6</b>	<b>0</b>
48.P3/P5/31/52	AC	<b>0 - 5</b>	0	<b>6</b>	0
48.P3/P5/31/52	Sensitive DC	<b>0 - 5</b>	0	<b>5</b>	0
48.P6/61	AC	<b>0 - 4</b>	0	<b>6</b>	0
48.P6/61	Sensitive DC	<b>0 - 4</b>	0	<b>5</b>	0
48.P8/62	Sensitive DC	<b>0 - 4</b>	0	<b>5</b>	0

## Technical data

Insulation		48.12/31/32/61/P3/P6	48.52/P5	48.12/31/61/62/P3/P6/P8	
Insulation according to EN 61810-1	insulation rated voltage	V 250	250	400	
	rated impulse withstand voltage	kV 4	4	4	
	pollution degree	3	2	2	
	overvoltage category	III	III	III	
Insulation between coil and contacts (1.2/50 µs)		kV 6 (8 mm)			
Dielectric strength between open contacts		V AC 1000; 1500 (48.12/32)			
Dielectric strength between adjacent contacts		V AC 2000 (48.P5/52); 2500 (48.P8/62) 3000 (48.12/32)			
<b>Insulation between coil terminals</b>					
Rated impulse voltage (surge) differential mode (according to EN 61000-4-5)		kV(1.2/50 µs) 2			
<b>Other data</b>					
Bounce time: NO/NC		ms 2/5; 2/10 (48.12/32)			
Vibration resistance (10...200)Hz: NO/NC		g 20/5 (for 1 pole)	15/3; 20/6 (48.12/32) for 2 pole		
Power lost to the environment	without contact current	W 0.7			
	with rated current	W 1.2 (48.12/31/32/P3)	2 (48.52/P5/61/62/P6/P8)		
Wire strip length		mm 8			
⊕ Screw torque (only for 48.12/31/32/52/61/81)		Nm 0.5			
Min. wire size	<b>Screw terminal</b>		<b>Push-in terminal</b>		
		solid cable	stranded cable	solid cable	stranded cable
	mm <sup>2</sup>	0.5	0.5	0.5	0.5
	AWG	21	21	21	21
Max. wire size	<b>Screw terminal</b>		<b>Push-in terminal</b>		
		solid cable	stranded cable	solid cable	stranded cable
	mm <sup>2</sup>	1 x 6 / 2 x 2.5	1 x 4 / 2 x 2.5	2 x 1.5 / 1 x 2.5	2 x 1.5 / 1 x 2.5
	AWG	1 x 10 / 2 x 14	1 x 12 / 2 x 14	2 x 16 / 1 x 14	2 x 16 / 1 x 14



**Contact specification**

**F 48 - Electrical life (AC) v contact current**  
Types 48.P3/P6/31/61

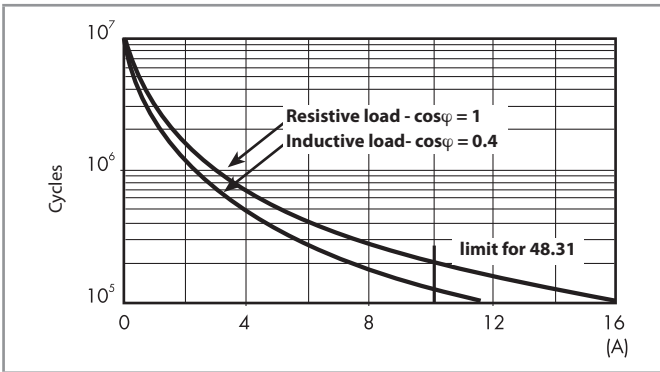

**F 48 - Electrical life (AC) v contact current**  
Types 48.P8/62

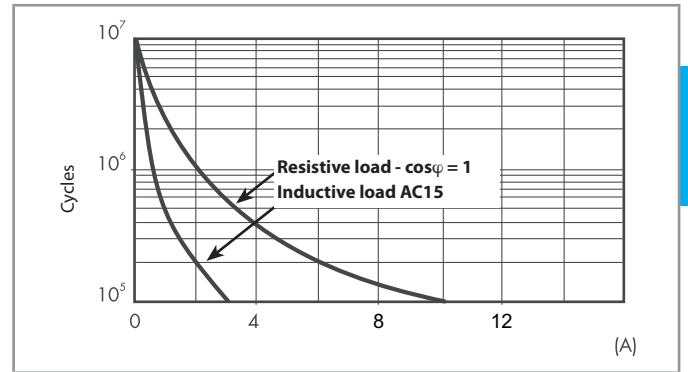

**F 48 - Electrical life (AC) v contact current**  
Types 48.P5/52

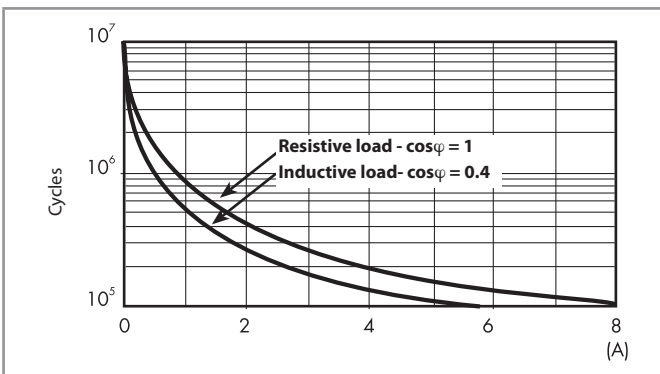

**F 48 - Electrical life (AC) v contact current**  
Type 48.12/32

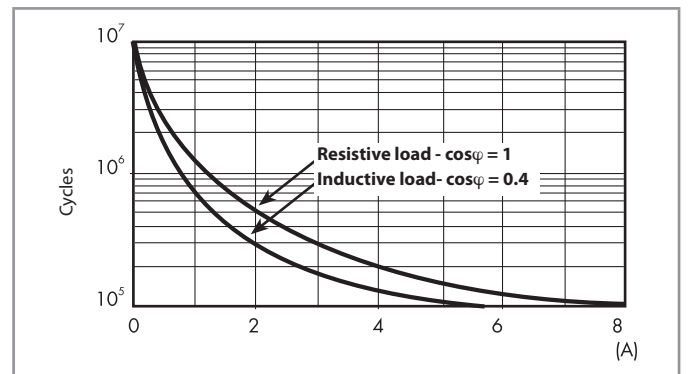

**H 48 - Maximum DC1 breaking capacity**  
Types 48.P3/P5/P6/31/52/61

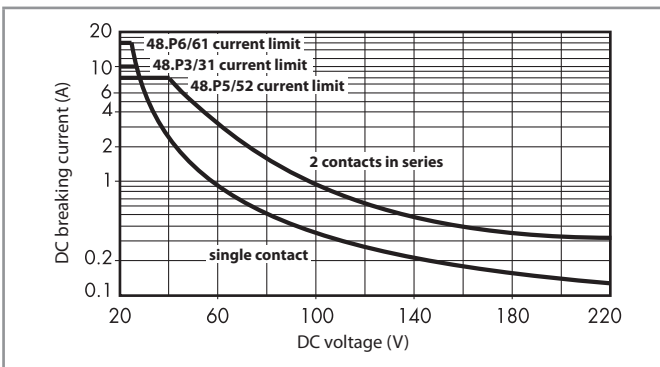

**H 48 - Maximum DC1 breaking capacity**  
Types 48.P8/62

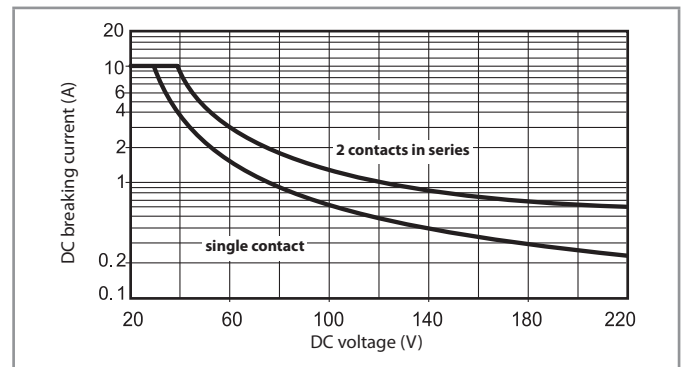

**H 48 - Maximum DC1 breaking capacity**  
Type 48.12/32

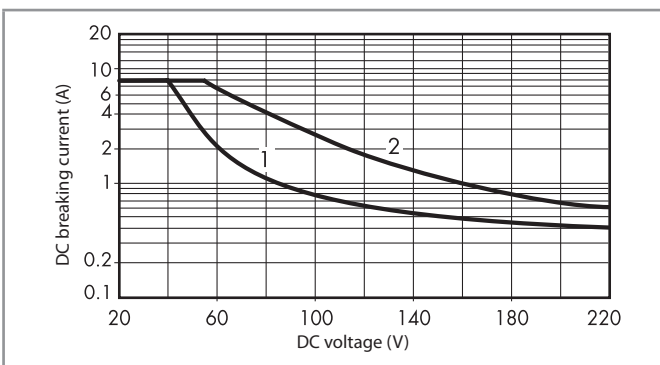

- When switching a resistive load (DC1) having voltage and current values under the curve, an electrical life of  $\geq 100 \cdot 10^3$  can be expected.
  - In the case of DC13 loads, the connection of a diode in parallel with the load will permit a similar electrical life as for a DC1 load.
- Note: the release time for the load will be increased.

## Coil specifications

### DC coil data (0.5 W sensitive)

Nominal voltage $U_N$	Coil code	Operating range		Rated coil consumption I at $U_N$
		$U_{min}^*$	$U_{max}$	
V		V	V	mA
12	7.012	8.8	18	41
24	7.024	17.5	36	22.2
125	7.125	91	188	4

\*  $U_{min} = 0.8 U_N$  for 48.61, 48.62, 48.P6, 48.P8

### AC coil data

Nominal voltage $U_N$	Coil code	Operating range		Rated coil consumption I at $U_N$ (50 Hz)
		$U_{min}$	$U_{max}$	
V		V	V	mA
12	8.012	9.6	13.2	90.5
24	8.024	19.2	26.4	46
110	8.110	88	121	10.1
120	8.120	96	132	11.8
230	8.230	184	253	7.0

### DC coil data, (0.7 W standard) - Type 48.12/48.32, (48.32 available only 24 V DC)

Nominal voltage $U_N$	Coil code	Operating range		Resistance R	Rated coil consumption I at $U_N$
		$U_{min}$	$U_{max}$		
V		V	V	$\Omega$	mA
12	9.012	9	14.4	205	58.5
24	9.024	18	28.8	820	29.3

### R 48 - DC coil operating range v ambient temperature

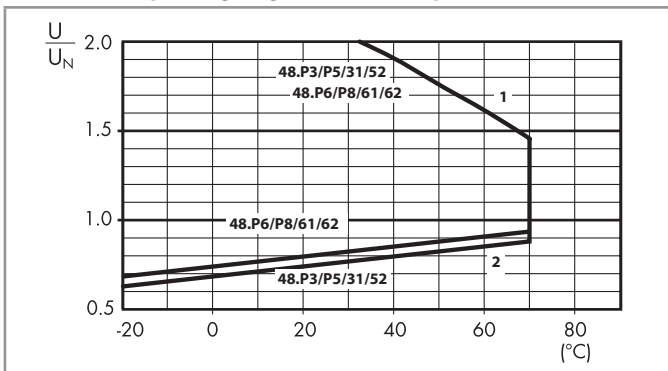

- 1 - Max. permitted coil voltage.
- 2 - Min. pick-up voltage with coil at ambient temperature.

### R 48 - AC coil operating range v ambient temperature

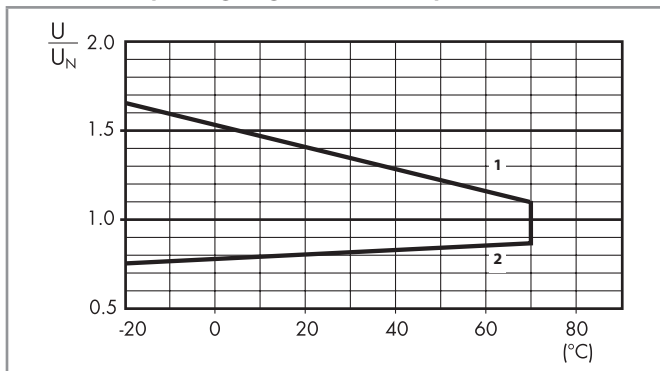

- 1 - Max. permitted coil voltage.
- 2 - Min. pick-up voltage with coil at ambient temperature.

### R 48 - DC coil operating range v ambient temperature Type 48.12/32

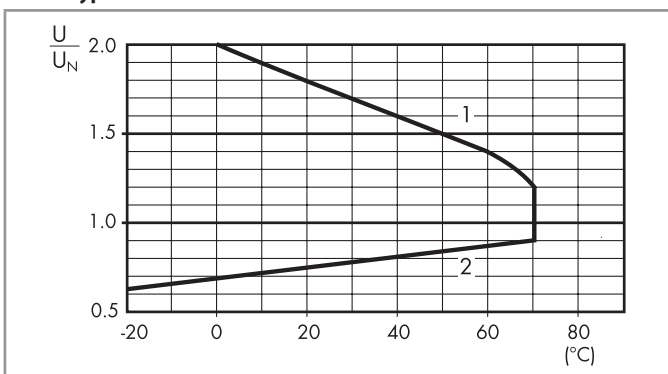

- 1 - Max. permitted coil voltage.
- 2 - Min. pick-up voltage with coil at ambient temperature.

**Combinations**

Code	Type of socket	Type of relay	Module	Retaining clip
48.12	95.05.7	50.12	—	095.71
48.32	95.05	50.12	99.02	095.01
48.31	95.03	40.31	99.02	095.01
48.52	95.05	40.52	99.02	095.01
48.61	95.05	40.61	99.02	095.01
48.62	95.05	40.62	99.02	095.01
48.P3	95.P3	40.31	99.02	095.91.3
48.P5	95.P5	40.52	99.02	095.91.3
48.P6	95.P5	40.61	99.02	095.91.3
48.P8	95.P5	40.62	99.02	095.91.3

**B**

**Outline drawings**

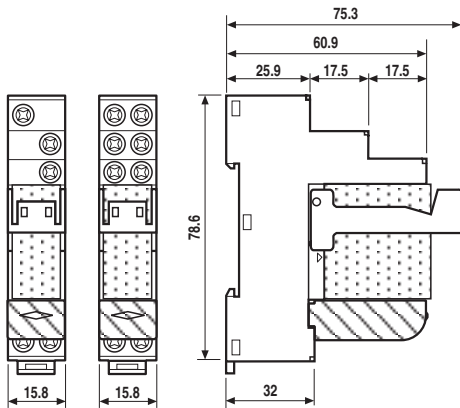

Types 48.31 48.32 / 48.52 / 48.61 / 48.62  
Screw terminal

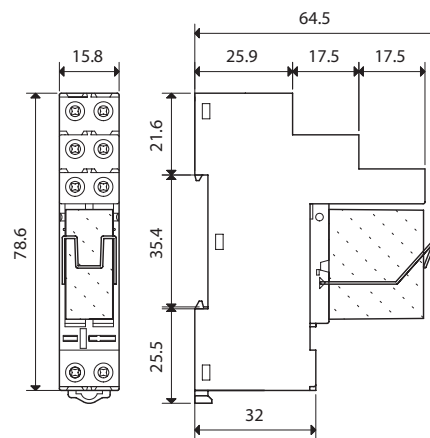

Type 48.12  
Screw terminal

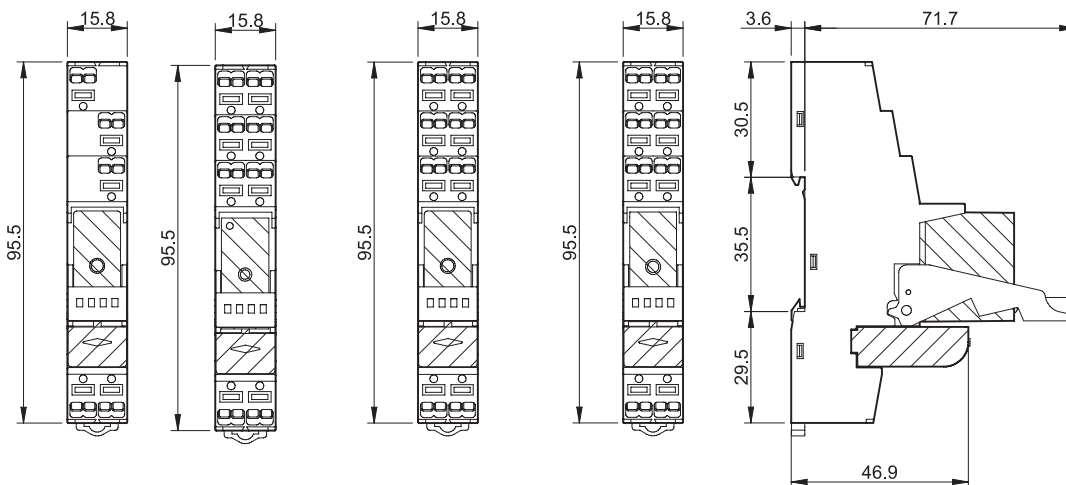

Types 48.P3      48.P5      48.P6      48.P8  
Push-in terminal



Accessories

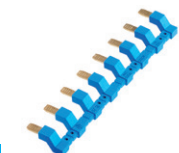

097.58

<b>8-way jumper link</b> for type 48.P3/P5/P6/P8	097.58
Rated values	10 A - 250 V

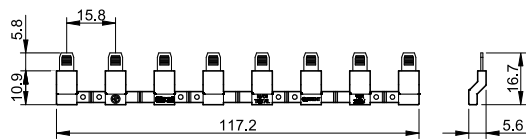

<b>2-way jumper link</b> for type 48.P3/P5/P6/P8	097.52
Rated values	10 A - 250 V

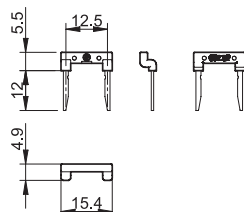

097.52

<b>2-way jumper link</b> for type 48.P3/P5/P6/P8	097.42
Rated values	10 A - 250 V

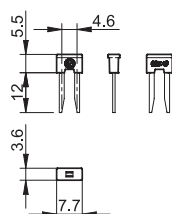

097.42

<b>Marker tag holder</b> for type 48.P3/P5/P6/P8 and 48.12/31/32/52/61/62	097.00
---	--------

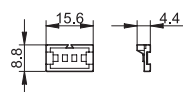

097.00

<b>8-way jumper link</b> for screw terminal version	095.18 (blue)	095.18.0 (black)
Rated values	10 A - 250 V	

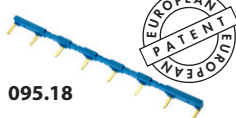
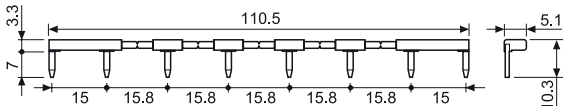

095.18



<b>Sheet of marker tags (CEMBRE Thermal transfer printers)</b> , plastic, 48 tags, 6 x 12 mm	060.48
--	--------

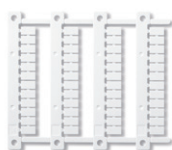

060.48

Packaging codes

How to code and identify retaining clip and packaging options for sockets.

Example:

4 8 . P 5 . 7 . 0 2 4 . 0 0 5 0 S P A

A Standard packaging  
B Blister packaging

SP Plastic retaining clip